

SeeSnake® LT1000

SeeSnake® LT1000



⚠ WARNING!

Read this Operator's Manual carefully before using this tool. Failure to understand and follow the contents of this manual may result in electrical shock, fire and/or serious personal injury.

SeeSnake® LT1000

Record Serial Number below and retain product serial number which is located on nameplate.

Serial
No.

--	--

Table of Contents

Recording Form for Machine Serial Number	1
Safety Symbols	3
General Safety Rules	3
Work Area Safety	3
Electrical Safety	3
Personal Safety	3
Equipment Use and Care	4
Battery Tool Use And Care	4
Service	4
Specific Safety Information	5
LT1000 Safety	5
Description, Specifications And Standard Equipment	5
Description	5
Specifications	6
Laptop System Requirements	6
Standard Equipment	6
Optional Equipment	6
LT1000 Components	6
Icons	7
Assembly	7
Mounting the LT1000	7
Mounting the LT1000 to the SeeSnake Mini Reel	7
Mounting the LT1000 to the SeeSnake Standard Reel	8
Installing the Stabilizers	10
LT1000 Mini	11
Preparing the Laptop	11
Pre-Operation Inspection	11
Work Area and Equipment Set Up	12
LT1000 Placement	12
Mounting the Laptop	12
Connecting the LT1000	13
Powering the SeeSnake LT1000	13
LT1000 Controls	14
Keypad Controls	14
About HQ Software	15
Operating Instructions	15
Starting Up	15
Inspecting the Line	15
Brightness Adjustment	15
Image Rotation	15
Count <i>Plus</i> Control	15
Locating The Camera Using The Sonde	15
Line Tracing The SeeSnake Pushrod	16
Maintenance Instructions	17
Cleaning	17
Accessories	17
Transport And Storage	17
Service And Repair	17
Disposal	17
Battery Disposal	17
Troubleshooting	18
Lifetime Warranty	Back Cover

*Original Instructions - English

Safety Symbols

In this operator's manual and on the product, safety symbols and signal words are used to communicate important safety information. This section is provided to improve understanding of these signal words and symbols.



This is the safety alert symbol. It is used to alert you to potential personal injury hazards. Obey all safety messages that follow this symbol to avoid possible injury or death.

⚠ DANGER

DANGER indicates a hazardous situation which, if not avoided, will result in death or serious injury.

⚠ WARNING

WARNING indicates a hazardous situation which, if not avoided, could result in death or serious injury.

⚠ CAUTION

CAUTION indicates a hazardous situation which, if not avoided, could result in minor or moderate injury.

NOTICE

NOTICE indicates information that relates to the protection of property.



This symbol means read the operator's manual carefully before using the equipment. The operator's manual contains important information on the safe and proper operation of the equipment.



This symbol means always wear safety glasses with side shields or goggles when handling or using this equipment to reduce the risk of eye injury.



This symbol indicates the risk of electrical shock.

General Safety Rules

⚠ WARNING

Read all safety warnings and instructions. Failure to follow the warnings and instructions may result in electric shock, fire and/or serious injury.

SAVE ALL WARNINGS AND INSTRUCTIONS FOR FUTURE REFERENCE!

Work Area Safety

- **Keep work area clean and well lit.** Cluttered or dark areas invite accidents.
- **Do not operate equipment in explosive atmospheres, such as in the presence of flammable liquids, gases or dust.** Equipment can create sparks which may ignite the dust or fumes.
- **Keep children and by-standers away while operating equipment.** Distractions can cause you to lose control.

Electrical Safety

US Model

- **Double-insulated tools are equipped with a polarized plug (one blade wider than the other). This plug will fit in a polarized outlet only one way. If the plug does not fit fully in the socket, reverse the plug. If it still does not fit, contact a qualified electrician to install a polarized outlet. Do not change the plug in any way.**

EU Model

- **Double-insulated tools are equipped with a non-polarised 2 pin plug.** Double insulation eliminates the need for the three-wire grounded power cord and grounded supply system.
- **Avoid body contact with earthed or grounded surfaces such as pipes, radiators, ranges and refrigerators.** There is an increased risk of electrical shock if your body is earthed or grounded.
- **Do not expose equipment to rain or wet conditions.** Water entering equipment will increase the risk of electrical shock.
- **Do not abuse the cord. Never use the cord for carrying, pulling or unplugging the equipment. Keep cord away from heat, oil, sharp edges or moving parts.** Damaged or entangled cords increase the risk of electric shock.
- **If operating equipment in a damp location is unavoidable, use a ground fault circuit interrupter (GFCI) protected supply.** Use of a GFCI reduces the risk of electric shock.
- **Keep all electrical connections dry and off the ground. Do not touch equipment or plugs with wet hands.** This reduces the risk of electrical shock.

Personal Safety

- **Stay alert, watch what you are doing and use common sense when operating equipment. Do not use equipment while you are tired or under the influence of drugs, alcohol or medication. A**

moment of inattention while operating equipment may result in serious personal injury.

- **Use personal protective equipment. Always wear eye protection.** Protective equipment such as dust mask, non-skid safety shoes, hard hat, or hearing protection used for appropriate conditions will reduce personal injuries.
- **Do not overreach. Keep proper footing and balance at all times.** This enables better control of the equipment in unexpected situations.
- **Dress properly. Do not wear loose clothing or jewelry. Keep your hair, clothing, and gloves away from moving parts.** Loose clothes, jewelry, or long hair can be caught in moving parts.

Equipment Use and Care

- **Do not force equipment. Use the correct equipment for your application.** The correct equipment will do the job better and safer on the job for which it is designed.
- **Do not use equipment if the switch does not turn it ON and OFF.** Any equipment that cannot be controlled with the switch is dangerous and must be repaired.
- **Disconnect the plug from the power source and/or the battery pack from the equipment before making any adjustments, changing accessories, or storing.** Such preventive safety measures reduce the risk of injury.
- **Store idle equipment out of the reach of children and do not allow persons unfamiliar with the equipment or these instructions to operate the equipment.** Equipment can be dangerous in the hands of untrained users.
- **Maintain equipment.** Check for misalignment or binding of moving parts, missing parts, breakage of parts and any other condition that may affect the equipment's operation. If damaged, have the equipment repaired before use. Many accidents are caused by poorly maintained equipment.
- **Use the equipment and accessories in accordance with these instructions, taking into account the working conditions and the work to be performed.** Use of the equipment for operations different from those intended could result in a hazardous situation.
- **Use only accessories that are recommended by the manufacturer for your equipment.** Accessories that may be suitable for one piece of equipment may become hazardous when used with other equipment.

- **Keep handles dry and clean; free from oil and grease.** Allows for better control of the equipment.

Battery Tool Use And Care

- **Recharge only with the charger specified by the manufacturer.** A charger that is suitable for one type of battery pack may create a risk of fire when used with another battery pack.
- **Use equipment only with specifically designated battery packs.** Use of any other battery packs may create a risk of injury and fire.
- **Do not probe battery with conductive objects. When battery pack is not in use, keep it away from other metal objects, like paper clips, coins, keys, nails, screws or other small metal objects that can make a connection from one terminal to another.** Shorting the battery terminals together may cause burns or a fire.
- **Under abusive conditions, liquid may be ejected from the battery; avoid contact. If contact accidentally occurs, flush with water. If liquid contacts eyes, additionally seek medical help.** Liquid ejected from the battery may cause irritation or burns.
- **Use and store batteries and chargers in dry, appropriate temperature areas.** Extreme temperatures and moisture can damage batteries and result in leakage, electrical shock, fire or burns. *See charger manual for more information.*
- **Do not cover charger while in use. Proper ventilation is required for correct operation.** Covering charger in use could result in fire.
- **Properly dispose of batteries.** Exposure to high temperatures can cause the batteries to explode, so do not dispose of in a fire. Some countries have regulations concerning battery disposal. Please follow all applicable regulations.

Service

- **Have your equipment serviced by a qualified repair person using only identical replacement parts.** This will ensure that the safety of the equipment is maintained.
- Remove the batteries and refer servicing to qualified service personnel under any of the following conditions:
 - If liquid has been spilled or objects have fallen into product;
 - If product does not operate normally by following the operating instructions;

- If the product has been dropped or damaged in any way; or,
- When the product exhibits a distinct change in performance.

Specific Safety Information

⚠ WARNING

This section contains important safety information that is specific to this equipment.

Read these precautions carefully before using the LT1000 to reduce the risk of electrical shock or other serious personal injury.

SAVE THESE INSTRUCTIONS!

Keep this manual with the machine for use by the operator.

The EC declaration of conformity (890-011-320.10) will accompany this manual as a separate booklet when required.

If you have any question concerning this RIDGID® product:

- Contact SeeSnake HQ Support Department at HQSupport@seesnake.com for questions relating to HQ.
- Contact your local RIDGID® distributor.
- Visit www.RIDGID.com or www.RIDGID.eu to find your local RIDGID contact point.
- Contact RIDGID Technical Services Department at rttechservices@emerson.com, or in the U.S. and Canada call (800) 519-3456.

LT1000 Safety

- **An improperly grounded electrical outlet can cause electrical shock and or severely damage equipment.** Always check work area for a properly grounded electrical outlet. Presence of a three prong or GFCI outlet does not insure that the outlet is properly grounded. If in doubt, have the outlet inspected by a licensed electrician.
- **Use only a battery or the included isolated power supply to power the LT1000. Use batteries or an isolated power supply with any laptop used with the LT1000.** This minimizes the risk of electrical hazards from moisture or faulty electrical outlets.
- **Do not operate this equipment if operator or machine is standing in water.** Operating machine while in water increases the risk of electrical shock.
- **The LT1000 is not waterproof. It is dust-resistant and splash-resistant.** Do not expose the equipment to water or rain. This increases the risk of electrical shock.

- **Do not use where a danger of high voltage contact is present.** The equipment is not designed to provide high voltage protection and isolation.
- **Read and understand this operator's manual, the reel operators' manual and the instructions for any other equipment in use and all warnings before operating the LT1000.** Failure to follow all instruction may result in property damage and/or serious personal injury.
- **Always use appropriate personal protective equipment while handling and using equipment in drains.** Drains may contain chemicals, bacteria and other substances that may be toxic, infectious, cause burns or other issues. Appropriate personal protective equipment always includes safety glasses, and may include equipment such as drain cleaning gloves or mitts, latex or rubber gloves, face shields, goggles, protective clothing, respirators and steel-toed footwear.
- **If using drain cleaning equipment at the same time as using drain inspection equipment, only wear RIDGID Drain Cleaning Gloves.** Never grasp the rotating drain cleaning cable with anything else, including other gloves or a rag. They can become wrapped around the cable, causing hand injuries. Only wear latex or rubber gloves under RIDGID Drain Cleaner Gloves. Do not use damaged drain cleaning gloves.
- **Practice good hygiene.** Use hot, soapy water to wash hands and other exposed body parts exposed to drain contents after handling or using drain inspection equipment. Do not eat or smoke while operating or handling drain inspection equipment. This will help prevent contamination with toxic or infectious material.

Description, Specifications And Standard Equipment

Description

The SeeSnake® LT1000 is a convenient interface and platform which allows any standard laptop to serve as a SeeSnake Inspection monitor, and can be used to automatically capture photos, motion clips and sound recordings from a SeeSnake Pipe Inspection System. It provides a convenient interface to SeeSnake HQ report generating and video managing software to make creating and managing customer reports quick and easy.

The LT1000 also provides a robust laptop platform to which the laptop can be rapidly secured and connected, and easily removed when needed. Two platform wings may be used to increase the work platform area.

The individual platform wings may be separately folded in, to provide platform support across the center of the SeeSnake, or they may be folded out to extend platform support at either end of the LT1000.

Specifications

LT1000

Weight.....	6.4 lbs. / 2,9 kg w/o Battery 7.35 lbs. / 3,3 kg with Battery (without Laptop)
Dimensions:	
Length, platform wings closed.....	20.6" / 52,3 cm
Length, platform wings open.....	21.7" / 55,1 cm
Width, Standard.....	12.8" / 32,5 cm
Width, Shipping.....	11.9" / 30,2 cm
Height.....	6.5" / 16,5 cm
Power Source.....	100 - 240V AC / 50 - 60Hz, AC or 18V DC Rechargeable Battery
Battery Type.....	18V Li-Ion, 2.2 Ah / 2,2 Ah
Power Rating	14 - 16V DC 40W
Operating Environment:	
Temperature.....	-4°F to 167°F / -20°C to 75°C
Humidity.....	5% to 95% RH
Altitude.....	13,120 feet / 4.000 meters

LT1000 Mini

Weight.....	6.1 lbs. / 2,78 kg w/o Battery 7.4 lbs. / 3,4 kg with Battery (without Laptop)
Dimensions:	
Length.....	13.6" / 34,5 cm
Width.....	11.9" / 30,2 cm
Height.....	6.5" / 16,5 cm

Laptop System Requirements

- Windows® 7, Windows Vista® (SP2), Windows XP (SP3) (Windows 7 is recommended)
- Intel® Pentium® or AMD Athlon™ 1.8GHz / 1,8GHz (2.4GHz / 2,4GHz or higher recommended) or Intel Core™ 2 Duo 2.4GHz / 2,4GHz
- GB system memory (2 GB recommended)
- DirectX® 9 or 10 compatible graphics card with 128 MB (256 MB or higher recommended)
- DirectX® 9 or higher compatible sound card
- 30 GB of disk space
- CD-ROM drive or Internet connection to install software
- 1 USB 2.0 port

- Optional: - DVD burner for creating DVD reports
Internet connection for emailing reports, uploading reports to Ridgid Connect, etc.
Recommended minimum screen resolution: 1024 x 768

Standard Equipment

- LT1000
- 100 - 220V AC to 15V DC Power Converter and Supply
- Operator's Manual
- Instructional DVD
- Stabilizers (4)
- USB Cable

Optional Equipment

Other auxiliary equipment used with the SeeSnake LT1000 may include:

- Rechargeable battery
- A RIDGID® locator/receiver (such as the SR-20, the SR-60, the Scout® or the NaviTrack® II)
- A RIDGID® transmitter (such as the ST-510, the ST-305, ST-33Q, the NaviTrack® Brick or the NaviTrack® 10-watt transmitter)
- The Count*Plus* Cable Counter cable-measurement system, normally built in to SeeSnake Pipe Inspection Systems

The LT1000 is protected under U.S. and international patents.

LT1000 Components

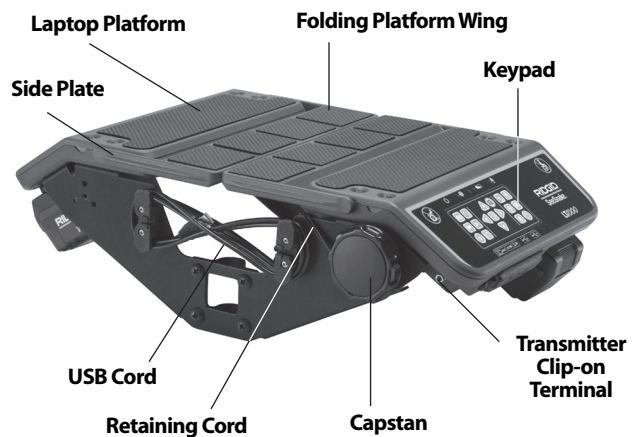

Figure 1 – Platform Wings Folded In

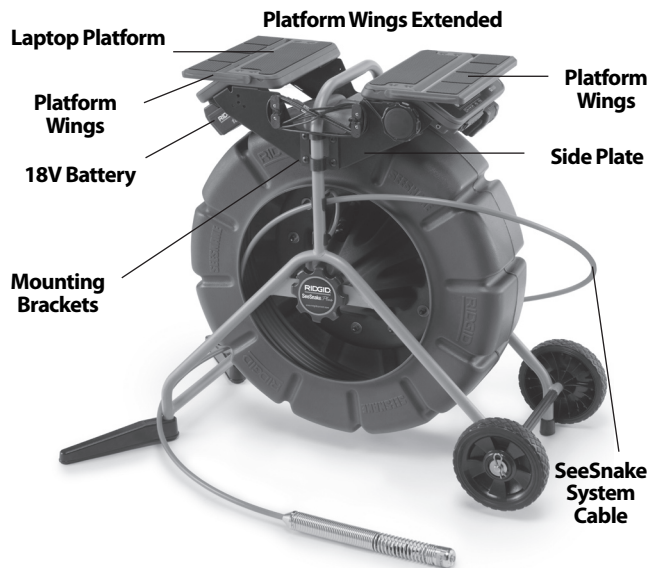

Figure 2 – LT1000 Components

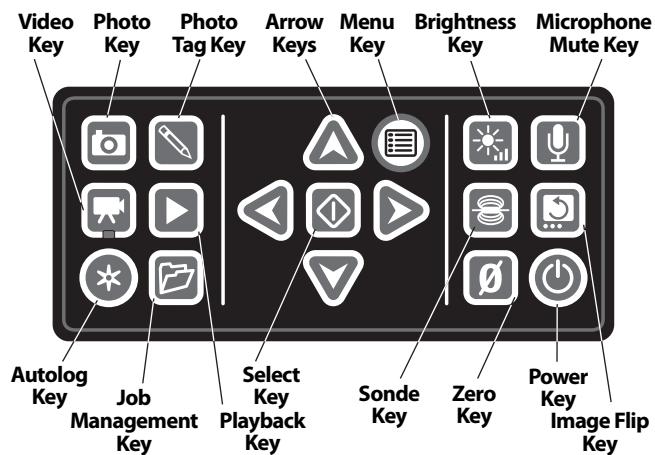

Figure 3 – LT1000 Keypad

Icons



Do not sit on the LT1000.



Do not stand on the LT1000.

Assembly

Mounting the LT1000

The LT1000 mounts to any Standard or Mini SeeSnake reel quickly and easily. Assembly requires a Phillips head screwdriver and a $\frac{7}{16}$ " / 11 mm box wrench. The mounting sequence for the SeeSnake Mini is different than the sequence for the SeeSnake Standard.

Note that for the Standard SeeSnake reel, the curved portions of the mounting brackets are oriented to the out-

side of the LT1000 while for the Mini's narrower frame, the curved portions of the brackets point inward.

Mounting the LT1000 to the SeeSnake Mini Reel

1. Remove the two mounting brackets from the sides of the LT1000.
2. Before mounting the LT1000 on the frame, lead the SeeSnake System Cable up to the SeeSnake System Connector. The SeeSnake System Cable has a guide ridge molded into the top of the cable connector. With the guide ridge aligned with the guide pin at the top of the receptacle, insert the System Cable into the System Connector firmly and turn the locking sleeve clockwise to tighten it in position.

NOTICE When connecting/disconnecting the SeeSnake system cable, turn only the locking sleeve. To prevent damage, do not bend or twist the connector or cable.

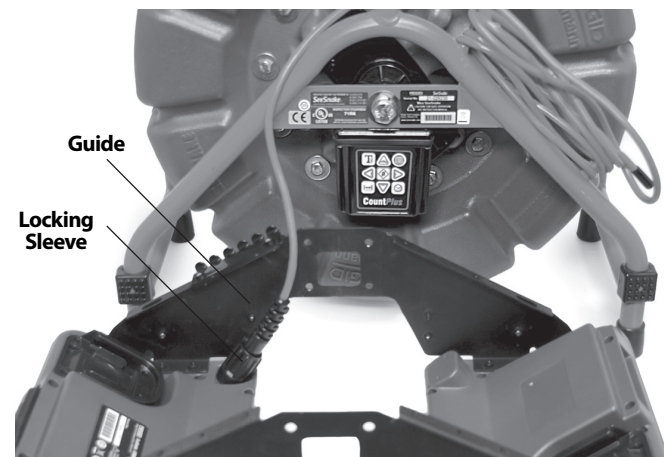

Figure 4 – Connecting System Cable Before Mounting

3. The Mini SeeSnake has the curved portions of the mounting brackets face inward. Position the LT1000 with the opening in the side plate seated over the "foot" on the SeeSnake Reel frame and hold it in its approximate position while starting the attaching machine screws on one side of the LT1000. The SeeSnake may be laid on its back for easier installation of the front side panel.

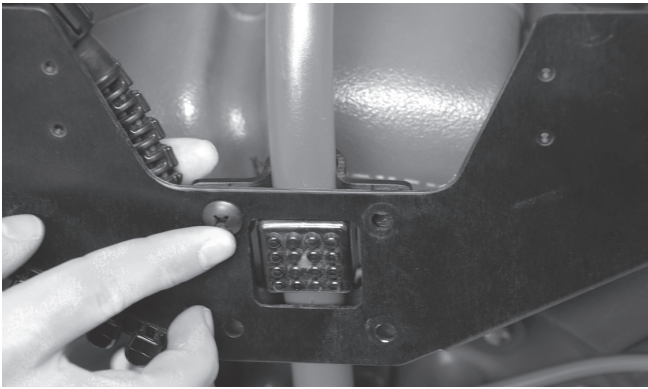

Figure 5 – First Machine Screw

4. With one side loosely bolted into position, align the opposite side and start the four machine screws on the opposite side. The screw-heads should be on the outer face of the LT1000 and the nuts on the inner face.

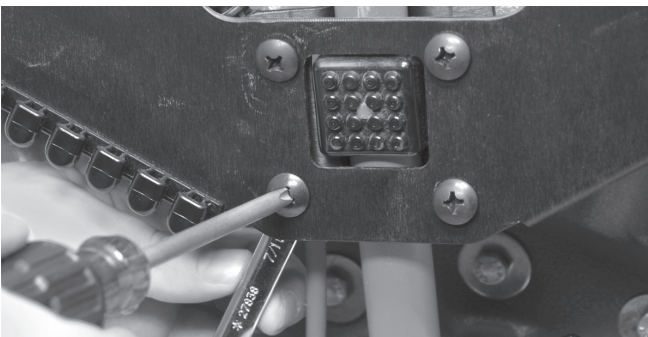

Figure 6 – Tightening Screws

5. Align the LT1000 so it is straight and level and hand-tighten down the four machine screws on each side. With the folding wings closed there should be about a 1" / 2,5 cm gap between the reel and the wings. Tighten all four machine screws down on each side with a Phillips head driver.
6. Rotate the capstan handle clockwise to loosen the laptop retaining cord and unhook the retaining cord from the cord hooks on the opposite side.
7. Fold the two platform wings in to the center position.

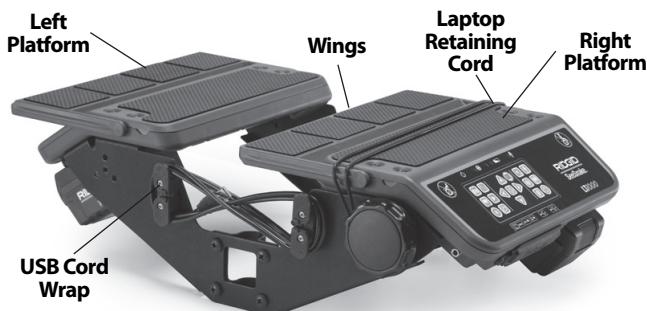

Figure 7 – Lowering the Platform Wings

Mounting the LT1000 to the SeeSnake Standard Reel

Mounting the LT1000 on a Standard SeeSnake reel requires removing the two laptop platform surfaces and the right-hand USB cord wrap from the LT1000 frame.

1. With a Phillips screwdriver, remove two screws from the USB cable wrap on the right side (the one which holds down the USB cable where it enters the LT1000). Unwind the USB cable from the cord wraps.
2. Remove the four screws from each platform half.

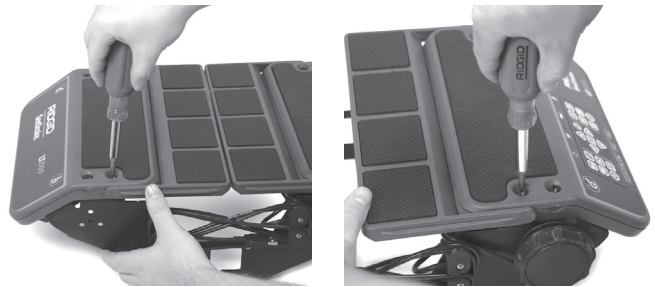

Figure 8 – Removing the Platform Screws (SeeSnake Standard)

3. Lift off the two platform halves and set them to one side close to the SeeSnake frame. *Save all screws carefully.*
4. The two side plates will then be free from the platform halves and may be individually installed.



Figure 9 – Parts of the LT1000

5. Move the front side plate under the upper handle of the SeeSnake Standard. *Be careful not to scrape against the frame.*
6. Place the mounting bracket over the outer bumper on the side of the SeeSnake and align the side plate to match the holes in the mounting bracket.

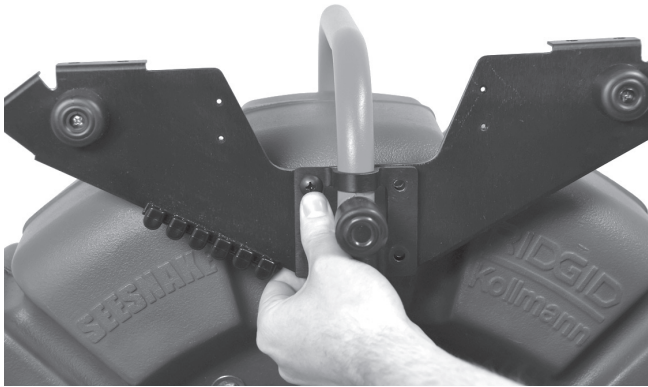

Figure 10 – Aligning the Bracket to the Side Plate

7. Insert the four screws through the mounting bracket and side plate into their individual nuts and hand tighten.

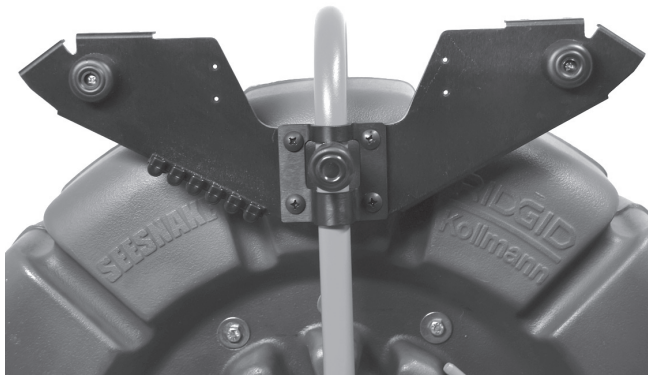

Figure 11 – Near Side-Plate Mounted

8. Repeat the process with the other side plate and mounting bracket. The two side plates should be level.
9. Route the SeeSnake System Cable from the SeeSnake between the side plates and connect it to the SeeSnake Connector on the bottom of the right-hand platform. The SeeSnake System Cable has a guide ridge molded into the top of the cable connector. With the guide ridge aligned with the guide pin of the receptacle, insert the System Cable into the System Connector firmly and turn the locking sleeve clockwise to tighten it in position.

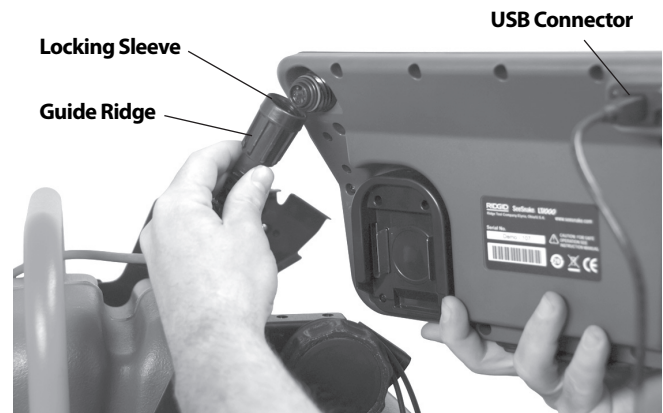

Figure 12 – Attaching the SeeSnake System Cable

NOTICE When connecting/disconnecting the SeeSnake system cable, turn only the locking sleeve. To prevent damage, do not bend or twist the connector or cable.



Figure 13 – Mounting Right-Hand Platform

10. Mount the right hand (keyboard) platform by aligning it with the mounting holes in the flanges of the side plates and screw it hand tight with four screws. Adjust the platform so it is level.



Figure 14 – Alignment Pin and Hole

A small alignment pin at each end of each platform should fit into a matching hole to seat the platform side fully.

11. Locate the left hand laptop platform, which is the one without the keyboard. Align it to the four holes (in the flanges of the side plates) and insert the four screws and hand-tighten them.

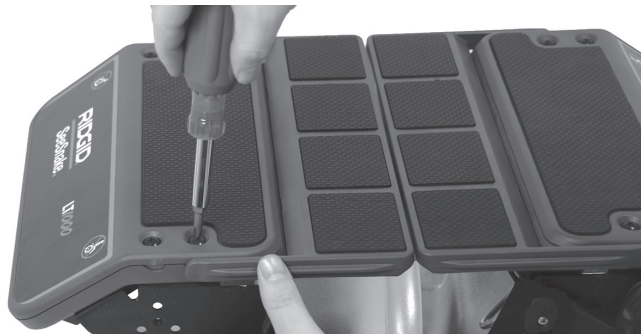

Figure 15 – Mounting the Left-Hand Platform

12. Adjust the platforms and side plates so the platforms are aligned and level. Fully tighten down the screws on the brackets and the mounting screws for the laptop platforms.
13. Replace the right-hand cord-wrap and fasten it into place with two screws. Note that the USB cable is captured under the cord-wrap post as it exits the LT1000.



Figure 16 – Mounting the Cord-Wrap (Note USB Cable captured under Cord-Wrap)



Figure 17 – Cord-wrap and USB Cable

Installing the Stabilizers

Stabilizers are supplied with the LT1000 which provide greater reel stability when they are rotated out. Each stabilizer has a spring-loaded plate inside it which holds the stabilizer in place when installed.



Figure 18 – Stabilizers with Mini Reel

To install the stabilizers:

1. Remove the rubber foot from a leg of the frame.
2. Slide the stabilizer onto the leg of the frame, with the solid face toward the top of the frame.
3. Replace the rubber foot and seat it firmly.
4. Repeat for all four legs. On the larger Standard unit, install stabilizers only on the legs without wheels.



Figure 19 – Stabilizers installed

LT1000 Mini



Figure 20 – LT1000 Mini

The LT1000 Mini is a sturdy portable frame supporting an LT1000 unit. It is light-weight, easy-to-carry and can be used with any SeeSnake reel simply by connecting the SeeSnake System Cable. It is an economical alternative if you need to shift your LT1000 between SeeSnake reels frequently. The LT1000 Mini is shipped with the LT1000 unit already installed on the portable frame.

Preparing the Laptop

To operate correctly with the LT1000, the laptop to be used must have SeeSnake HQ software installed on it.

HQ software enables you to create, manage and store images, audio and video from the LT1000. The software is on the CD that ships with the LT1000. To load the software from the CD:

You must install SeeSnake HQ and its drivers before connecting the LT1000 to your computer.

1. Insert the CD into the computer's CD drive.
2. The laptop should auto-detect the CD and begin the installation process. It may ask for an admin password before installing the HQ software.
3. When the software installation is complete, eject the CD and store it in a safe place.

NOTE! Software update checks will occur automatically when the laptop is connected to the Internet. If an update is detected you will be asked if you want to install it, and the update will occur automatically if you indicate you want it installed. The latest version can be checked for manually by placing the laptop on-line and pointing an Internet browser to <http://www.hq.ridgid.com/product-hq.php>.

4. Alternatively the software may be installed by browsing to the updates website given above and following the instructions found there.
5. For detailed instructions on using HQ software to manage your video clips, still photos, reports, customer information and formats, direct a web-connected browser to <http://www.hq.ridgid.com/>. You will find on-line user instructions for every aspect of HQ's capabilities there.

Pre-Operation Inspection

⚠ WARNING



Before each use, inspect your SeeSnake LT1000 and correct any problems to reduce the risk of serious injury from electrical shock or other causes and prevent machine damage.

1. Confirm that the power is OFF, any external power and cords are disconnected and the battery is removed. Inspect the cords, cables and connectors for damage or modification.
2. Clean any dirt, oil or other contamination from the SeeSnake LT1000 to aid in inspection and to prevent the unit from slipping from your grip while transporting or using.
3. Inspect the LT1000 for any broken, worn, missing, misaligned or binding parts, or any other condition which might prevent safe, normal operation. Ensure the LT1000 mounting brackets are securely tightened.

4. Inspect any other equipment being used per its instructions to make sure it is in good usable condition.
5. If any problems are found, do not use the unit until the problems are corrected.

Work Area and Equipment Set Up

⚠ WARNING



Set up the LT1000 and work area according to these procedures to reduce the risk of injury from electrical shock, fire and other causes, and to prevent damage to the LT1000.

1. Check work area for:
 - Adequate lighting.
 - Flammable liquids, vapors or dust that may ignite. If present, do not work in area until sources have been identified and corrected. The LT1000 is not explosion proof. Electrical connections can cause sparks.
 - Clear, level, stable dry place for operator. Do not use the machine while standing in water.
 - Clear path to electrical outlet, that does not contain any potential sources of damage for the power cord, when using external power.
2. Inspect the work to be done if possible, determine the drain access point(s), size(s) and length(s), presence of drain cleaning chemicals or other chemicals, etc. If chemicals are present, it is important to understand the specific safety measures required to work around those chemicals. Contact the chemical manufacturer for required information.
3. Determine the correct equipment for the application. The SeeSnake LT1000 is made to view inspections done with an inspection camera. Inspection equipment for other applications can be found by consulting the RIDGID Catalog, online at www.RIDGID.com or www.RIDGID.eu.
4. Make sure all equipment has been properly inspected.
5. Evaluate the work area and determine if any barriers are needed to keep bystanders away. Bystanders can distract the operator during use. If working near traffic, erect cones or other barriers to alert drivers.
6. If needed, remove fixture (water closet, sink, etc.) to allow access.

LT1000 Placement

Position the SeeSnake Reel at the work site before mounting the laptop onto the LT1000. To access the carrying handle for the SeeSnake Reel, fold the platform wings back on both sides of the LT1000. The retaining cord may be routed under the platform and hooked to the cord hooks for transport.

Place the reel and LT1000 to allow easy access and viewing while manipulating the camera and pushrod for an inspection. Make sure that the location is not wet and will not let the LT1000 and other equipment get wet during use. The LT1000 is not waterproof and exposure to wet conditions can cause electrical shock or equipment damage.

Mounting the Laptop

1. Loosen the retaining cord by turning the capstan clockwise.
2. Place the laptop squarely on the laptop platform with the keyboard toward the LT1000 keypad.
3. Route the elastic retaining cord over the laptop and hook it over the cord hooks, routing the cord so as not to interfere with the laptop's operation.
4. Rotate the capstan handle counter-clockwise to tighten the retaining cord firmly.
5. Lead the LT1000 USB cord to the laptop's USB port and plug it into the port. Wrap any excess cord onto the USB cord wraps. (See Figure 7.)

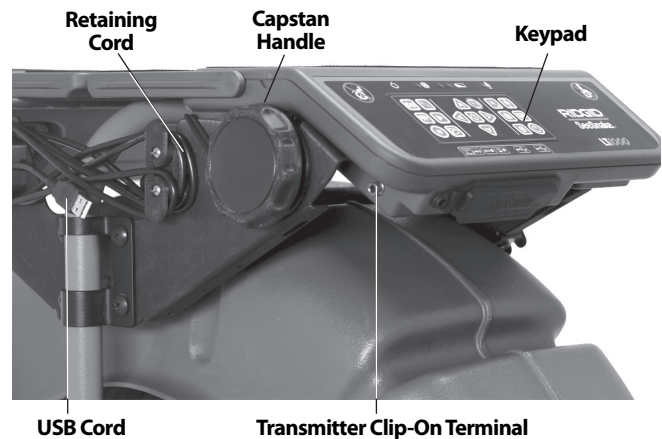

Figure 21 – Keypad, Capstan and USB Cord

Note that in constrained locations or on slanted surfaces or roofs, you may prefer to lay the SeeSnake on its side, unwrap the USB cord connecting the laptop and place the laptop in another secure location.



Figure 22 – Alternate Configuration For Constrained Spaces



Figure 23 – LT1000 Mini with Laptop

Connecting the LT1000

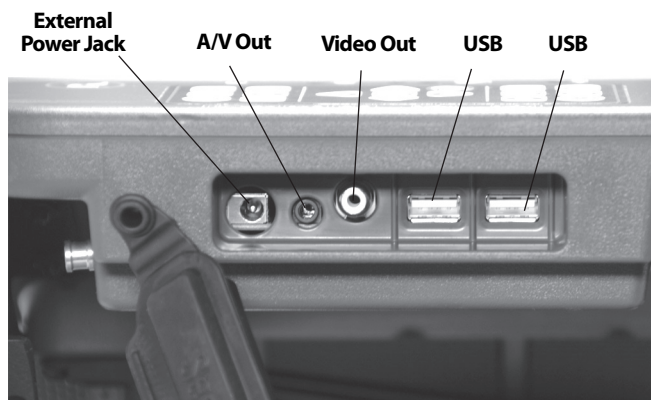

Figure 24 – LT1000 Connections

Connection Icons

	External Power Jack
	A/V Out Jack (External DVDR, ect.)
	Video Out Jack (External Monitor)
	USB Port (Thumb Drivers, ect.)

The USB ports may be used to connect an external keyboard if desired.

The front AV out jack will work even when HQ is not being used.

External Monitor Options

1. The LT1000 may be used with an external SeeSnake monitor by connecting an RCA cable from the Video IN port on the monitor. Connect the other end of the cable to the LT1000 video OUT port on the back of the LT1000, marked with
2. The A/V out port

The USB connection from the LT1000 only functions when connected to a device running SeeSnake HQ.

Powering the SeeSnake LT1000

The SeeSnake LT1000 can either be powered with a RIDGID Li-Ion rechargeable battery or plugged into an outlet using a supplied AC/DC power converter. Battery power is the preferred powering method to reduce the risk of electrical shock. **Additionally, the power converter is not rated for outdoor use and should only be used indoors.**

⚠ WARNING Use only a battery or an isolated power supply to power the LT1000 and any laptop used with it to reduce the risk of Electrical shock.

Battery Power

With dry hands, insert a charged 18V battery into the battery holder under the right side of the keypad. A spare battery may also be stored in the spare battery holder under the opposite end of the LT1000 on the opposite side. (The storage slot has no electrical connections and is for convenient storage only.)



Figure 25 – LT1000 Connections

Make sure that the battery locks onto the dock. See the Battery Charger operator’s manual for more information.

Batteries supplied for the LT1000 are rated at 2.2 / 2,2 amp-hours. When fully charged, depending on use (recording time, etc.) the LT1000 will run for approximately 2.5 / 2,5 to 3 hours. Battery Status LEDs above keypad indicate battery charge level. (See *Battery Status LED chart*.)

NOTICE Turn the LT1000 power OFF before changing or removing the battery. Removing the battery with the power ON may cause loss of camera recordings.

Battery Status LEDs Chart

BATTERY STATUS	EXTERNAL POWER NOT CONNECTED	EXTERNAL POWER CONNECTED
FULL	Solid green	LEDs OFF
MED	Solid green and red	LEDs OFF
LOW	Solid red, 4 beeps	LEDs OFF
DEAD	Solid red for 5 sec, 5 sec long beep and shutdown	LEDs OFF

Outlet Power

For plug in operation, a double-insulated AC/DC power supply is supplied to reduce wall outlet voltage to the correct voltage for the LT1000.

NOTICE The external power supply is intended for indoor use only.

To power the system up with the power cord, locate the power supply. The power supply cord has two sections, one of which plugs into a standard 110 - 120V two-bladed outlet (US model) or standard 230V 2 pin outlet (EU model) at one end and plugs into a power supply at the other end. The second section runs from the power supply to the back of the LT1000 and plugs into the jack marked  at the far left side front panel of the unit (Figure 24).

With dry hands, connect the two sections together and insert the jack plug into the jack on the LT1000. Route the cord along a clear path and with dry hands plug the power supply into a matching outlet. If using an extension cord ensure it is of adequate wire gauge. For cords of 25 feet / 7,5 m, a minimum gauge of 18 AWG / 0,8 mm² is required. For cords greater than 25 feet / 7,5 m, a minimum gauge of 16 AWG / 1,5 mm² is required.















NOTICE If external power is unreliable and produces transient voltage spikes, the LT1000 video may freeze. In this case simply power cycle the LT1000 off and then on. Job data will not be lost, but current distance count may be reset.

WARNING If the laptop is plugged into AC and the laptop AC adapter is not isolated, then a hot ground could damage a laptop via the USB grounding connection.

Use only a battery or an isolated power supply to power the LT1000 and any laptop used with it.

LT1000 Controls

Keypad Controls

-  **Arrow Keys:** Used to move among menu choices and adjust variables (such as contrast) up and down. Used to rotate screen image.
-  **Select Key:** Used to choose options in the Units menu (Auto, Meters and Feet).
-  **Menu Key:** Used to bring up a menu of display options such as Color, Brightness, Contrast, Units.
-  **Brightness Key:** Used to directly control the camera LED’s brightness up or down.
-  **Microphone Mute Key:** Used to mute the microphone while recording or activate it to record comments during an inspection.
-  **Sonde Key:** Used to activate the built-in Sonde for tracing the location of the camera head.
-  ***Image Flip Key:** Used to flip the image on the display vertically
-  **Zero Key:** Used to establish a temporary zero-point for the distance counter for units equipped with the CountPlus.
-  **Power Key:** Used to power the LT1000 display ON or OFF.
-  ***Photo Key:** Captures a still photo of the camera image as shown.
-  ***Video Key:** Starts or stops the capture of a video clip.
-  ***Autolog Key:** Starts Autologging capture of a series of still photos stored with the current job.
-  ***Photo Tag Key:** Creates a new still photo and allows you to apply custom comments or stored tags to it.
-  ***Job Management Key:** Accesses a menu of job and report management options.
-  ***Playback Key:** Plays back current recording, if any.

* Some of the keypad controls will have no effect unless the HQ Software is running.

About HQ Software

HQ software enables you to create, manage and store images, audio and video from the LT1000. You can use HQ to quickly and automatically create reports which can be emailed to a customer, or created in HTML form and handed to the customer on a thumb drive, or burned to DVD. HQ software also makes it easy to organize and store job records for future reference if needed.

HQ software is described in detail in the HQ built-in help files found at <http://www.hq.ridgid.com/>.

Operating Instructions

⚠ WARNING





Always wear eye protection to protect your eyes against dirt and other foreign objects.

When inspecting drains that might contain hazardous chemicals or bacteria, wear appropriate protective equipment, such as latex gloves, goggles, face shields or respirators, to prevent burns and infections.

Do not operate this equipment if operator or machine is standing in water. Operating machine while in water increases the risk of electrical shock. Rubber soled, non-slip shoes can help prevent slipping and electric shock, especially on wet surfaces.

Follow operating instructions to reduce the risk of injury from electrical shock and other causes.

Starting Up

1. Check that the unit is properly set up.
2. Ensure the laptop is in place and properly connected and that the laptop has the HQ Software installed on it. Turn the laptop ON.
3. Place the camera head into the reel's guide hoop and turn the LT1000's power ON .
4. When the LT1000 starts up, the laptop will detect the SeeSnake device and will start HQ running. If it does not, double-click the HQ icon  on your desktop to launch it.
5. By default it will start a new Job which will come up showing the image from the camera head.
6. For detailed instructions on the HQ software see the built-in help files found at <http://www.hq.ridgid.com/>.

Inspecting the Line

1. Power up the LT1000 if it is OFF.
2. Put the camera head in the line. Zero the counter if desired.
3. Proceed with pipe inspection as described in your SeeSnake manual.

Brightness Adjustment







You may find you need to increase or decrease the camera LED brightness while inspecting the inside of a line, depending on conditions. To do so simply press the Brightness Key  and raise or lower the brightness level using the Arrow Keys  . Press the Menu Key  when done.

Image Rotation

While doing an inspection the camera may become rotated in the line and present an inverted image. The Flip Key  will rotate the image on the screen (flip it vertically) for easier viewing. The HQ software will also allow you to straighten the camera image by degrees.

CountPlus Control

If you are using a SeeSnake reel equipped with the CountPlus distance counter, the measured distance will appear on the display connected to the LT1000. If you want to set an interim zero-point to measure distance from some location (such as a junction or pipe-head) pressing the Zero Key  will start a temporary distance count, with the number displayed in square brackets [0.0]. For details on using the Zero Key see *the CountPlus manual*.

CountPlus parameters such as date and time are set using the CountPlus menu key and going to the CountPlus Tools menu. CountPlus text overlays are managed with the CountPlus keypad as described in the CountPlus Operator's Manual.

Locating The Camera Using The Sonde

Many SeeSnake pipe inspection systems have a built-in Sonde which transmits a locatable 512Hz signal. When the Sonde is turned ON, a locator such as the RIDGID SR-20, SR-60, Scout™ or NaviTrack® II set to 512Hz will be able to detect it, allowing you to detect the camera's location underground.

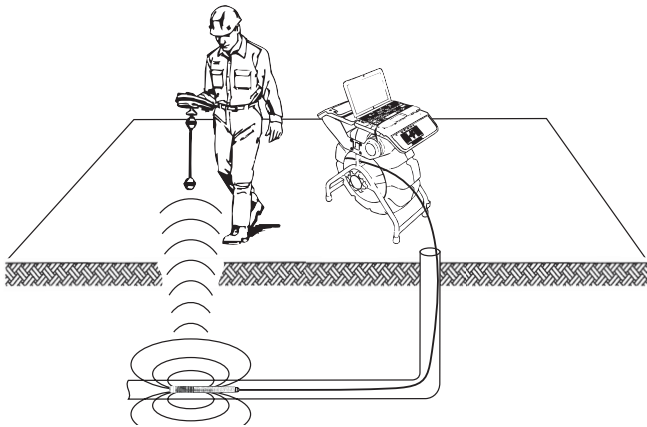



Figure 26 – Locating the Sonde

To turn the SeeSnake Sonde ON while using the LT1000, press the Sonde Key . A Sonde icon will appear on the display while the Sonde is ON. The display may also show some lines of interference from the Sonde's transmission. These will vanish when the Sonde is turned OFF by again pressing the Sonde Key .

The most workable approach to tracking the Sonde is to run the pushrod into the pipe about five or ten feet / 1,5 to 3 meters and use the locator to find the Sonde's position. If desired, you can then extend the pushrod a similar distance further down-pipe and locate the Sonde again starting from the previous located position. To locate the Sonde, turn the locator ON and set it to Sonde mode. Scan in the direction of the Sonde's probable location until the locator detects the Sonde. Once you have detected the Sonde, use the locator indications to zero in on its location precisely. *For detailed instructions on Sonde locating, consult the Operator's Manual for the locator model you are using.*

Line Tracing The SeeSnake Pushrod

The LT1000 also enables you to trace the line of the pushrod underground, using a standard RIDGID locator such as the NaviTrack® II, the Scout™, the SR-20 or the SR-60. To line-trace the SeeSnake pushrod, simply connect a line transmitter with one connector well-grounded to the grounding stake and the other connector clipped to the Transmitter Clip-on Terminal. The Transmitter Clip-on Terminal is a metal lug located just under the left end of the keyboard area as shown in *Figure 27*.



Figure 27 – LT1000 Transmitter Clip-on Terminal

Set the line transmitter and the locator to the same frequency, such as 33kHz and use the locator to trace the line (*Figure 28*). The camera's built-in 512Hz Sonde may be on at the same time, and if your locator is equipped with SimulTrace™ dual-frequency capability, you can follow the pushrod all the way to the camera's location and then detect the Sonde in the camera as you approach it above ground.

If you don't have the SimulTrace™ feature, use a line transmitter and a locator to line-trace the pushrod. When the signal fades, switch the locator to Sonde mode at the frequency of the in-line Sonde, usually 512Hz. Pick the signal up from where the line-trace frequency started to weaken and zero in on the in-line Sonde. Because locating frequencies from transmitters can cause distortion of the image on the monitor, it is best to turn Sonde and line transmitters OFF while inspecting the interior of a line and turn them ON only when ready to do a locate.

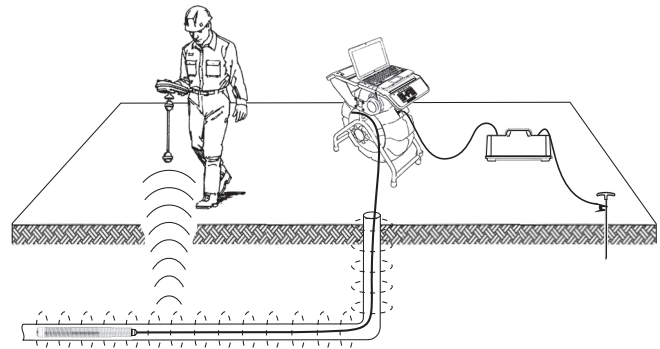

Figure 28 – Line Tracing the Pushrod

Maintenance Instructions

Cleaning

⚠ WARNING

Make sure all cords and cables are disconnected and the battery removed prior to cleaning the LT1000 to reduce the risk of electrical shock.

Do not use liquid or abrasive cleaners on the LT1000. Clean with damp cloth. Do not allow liquid to enter LT1000.

Accessories

⚠ WARNING

The following accessories have been designed to function with the LT1000. Other accessories suitable for use with other equipment may become hazardous when used with the LT1000. To reduce the risk of serious injury, only use accessories specifically designed and recommended for use with the LT1000, such as those listed in the following chart.

Catalog #		Description
US	EU	
32743	28218	18V Li-Ion rechargeable battery
27958	32073	Battery charger

Transport And Storage

Remove batteries before shipping. Do not expose to heavy shocks or impacts during transport. If storing for an extended period, remove batteries. Store within temperature range of 14°F to 158°F / -10°C to 70°C.

Store electrical devices in a dry place to reduce the risk of electrical shock.

Protect against excessive heat. The unit should be situated away from heat sources such as radiators, heat registers, stoves or other products (including amplifiers) that produce heat.

Service And Repair

⚠ WARNING

Improper service or repair can make the LT1000 unsafe to operate.

Service and repair of the SeeSnake LT1000 and LT1000 Mini must be performed by a RIDGID Independent Authorized Service Center.

For information on your nearest RIDGID Independent Service Center or any service or repair questions:

- Contact your local RIDGID distributor.
- Visit www.RIDGID.com or www.RIDGID.eu to find your local RIDGID contact point.
- Contact RIDGID Technical Services Department at rttechservices@emerson.com, or in the U.S. and Canada call (800) 519-3456.

E-mail SeeSnake HQ Support Department at HQSupport@seesnake.com

Disposal

Parts of the unit contain valuable materials and can be recycled. There are companies that specialize in recycling that may be found locally. Dispose of the components in compliance with all applicable regulations. Contact your local waste management authority for more information.



For EC Countries: Do not dispose of electrical equipment with household waste!

According to the European Guideline 2002/96/EC for Waste Electrical and Electronic Equipment and its implementation into national legislation, electrical equipment that is no longer usable must be collected separately and disposed of in an environmentally correct manner.

Battery Disposal



For USA and Canada: The RBRC™ (Rechargeable Battery Recycling Corporation) Seal on the battery packs means that RIDGID has already paid the cost of recycling the lithium-ion battery packs once they have reached the end of their useful life.

RBRC™, RIDGID®, and other battery suppliers have developed programs in the USA and Canada to collect and recycle rechargeable batteries. Normal and rechargeable batteries contain materials that should not be directly disposed of in nature, and contain valuable materials that can be recycled. Help to protect the environment and conserve natural resources by returning your used batteries to your local retailer or an authorized RIDGID service center for recycling. Your local recycling center can also provide you with additional drop off locations.

RBRC™ is a registered trademark of the Rechargeable Battery Recycling Corporation.

For EC countries: Defective or used battery packs/batteries must be recycled according to the guideline 2006/66/EC.

Chart 1 Troubleshooting

PROBLEM	PROBABLE FAULT LOCATION	SOLUTION
Camera video image not seen.	<p>No power to SeeSnake.</p> <p>.....</p> <p>Connections faulty.</p> <p>.....</p> <p>Batteries Low.</p>	<p>Check power is correctly plugged in or battery is charged.</p> <p>.....</p> <p>Check Power Key on LT1000 by pressing.</p> <p>.....</p> <p>Check connection to LT1000 unit from SeeSnake.</p> <p>.....</p> <p>Check seating and pin condition in the SeeSnake System connection. Clean if needed.</p> <p>.....</p> <p>Recharge batteries or connect external power supply.</p>
Flashing Battery Warning appears.	<p>LT1000 18V batteries low.</p>	<p>Recharge LT1000 batteries. Switch to AC power (110 - 240V AC).</p>
LT1000 video freezes.	<p>Low-quality AC power or voltage spike.</p>	<p>Power cycle the LT1000 OFF and then ON.</p>
No video.	<p>If your computer doesn't recognize the USB connection.</p> <p>.....</p> <p>Do not start your computer with the LT1000 turned ON.</p>	<p>Restart your computer, power cycle LT1000 or close HQ and restart it to see if this corrects the problem.</p> <p>.....</p> <p>The LT1000 should be turned OFF, though it's ok to have the USB cable plugged in.</p> <p>NOTE: The USB connector (<i>See Figure 12</i>) on the LT1000 was designed to be a water-resistant seal, so it is a tight fit. Your LT1000 was tested and shipped with this cable firmly connected. If you need to disconnect and reconnect this cable (for example, if you break your USB cable), make sure you push the connector in all the way. If you don't, the HQ software might not recognize the LT1000. If so, make sure you have pushed the connector in all the way. You may have to restart HQ to recognize the connection.</p>