

# SeeSnake® CS6x)) VERSA™



## **! WARNING!**

Read this Operator's Manual carefully before using this tool. Failure to understand and follow the contents of this manual may result in electrical shock, fire, and/or serious personal injury.



Companion Apps Available



For support and additional information about using your CS6x Versa go to [support.seesnake.com/cs6xversa](http://support.seesnake.com/cs6xversa) or scan this QR code.



# Table of Contents

## Introduction

Regulatory Statements ..... 3  
 Safety Symbols ..... 3

## General Safety Rules

Work Area Safety ..... 4  
 Electrical Safety ..... 4  
 Personal Safety ..... 4  
 Equipment Use and Care ..... 5  
 Battery Use and Care ..... 5  
 Pre-Operation Inspection..... 6

## SeeSnake CS6x Versa Overview

Description ..... 7  
 Specifications..... 8  
 Components ..... 9

## Operating Instructions

SeeSnake CS6x Versa Safety..... 10  
 Inspection Overview ..... 11  
 Connecting to a Camera Reel..... 11  
 Powering the System ..... 11  
 Keypad..... 12  
 User Interface ..... 14

## Viewing System

Mounting the CS6x Versa..... 16  
 Docking..... 16  
 Removing the Monitor..... 17

## Maintenance and Support

Product Support ..... 18  
 Software Updates..... 18  
 Cleaning..... 18  
 Transport and Storage ..... 18  
 Service and Repair..... 19  
 Disposal ..... 19

## Introduction

The warnings, cautions, and instructions discussed in this manual cannot cover all possible conditions and situations which may occur. It must be understood by the operator that common sense and caution are factors that cannot be built into this product, but must be supplied by the operator.

## Regulatory Statements

**CE** The EC Declaration of Conformity (890-011-320.10) will accompany this manual as a separate booklet when required.

Directive 2014/53/EU		
Radio	Operating Spectrum / Power	
Bluetooth 4.0	2402 – 2480 MHz	14.20 dBm
Wi-Fi 802.11 b/g/n	2400 – 2483.5 MHz	19.90 dBm
Wi-Fi 802.11 a/n	5150 – 5250 MHz	20.46 dBm
	5250 – 5350 MHz	18.32 dBm
	5470 – 5725 MHz	19.43 dBm

**FC** This device complies with Part 15 of FCC rules. Operation is subject to the following two conditions: (1) This device may not cause harmful interference, and (2) this device must accept any interference received, including interference that may cause undesired operation.

Contains Transmitter Module FCC ID: Z64-WL18SBMOD.

## Safety Symbols

In this manual and on the product, safety symbols and signal words are used to communicate important safety information. This section is provided to improve understanding of these signal words and symbols.



This is the safety alert symbol. It is used to alert you to potential personal injury hazards. Obey all safety messages that follow this symbol to avoid possible injury or death.

### **⚠ DANGER**

DANGER indicates a hazardous situation which, if not avoided, will result in death or serious injury.

### **⚠ WARNING**

WARNING indicates a hazardous situation which, if not avoided, could result in death or serious injury.

### **⚠ CAUTION**

CAUTION indicates a hazardous situation which, if not avoided, could result in minor or moderate injury.

**NOTICE** NOTICE indicates information that relates to the protection of property.



This symbol means read the manual carefully before using the equipment. The manual contains important information on the safe and proper operation of the equipment.



This symbol means always wear safety glasses with side shields or goggles when handling or using this equipment to reduce the risk of eye injury.



This symbol indicates the risk of electrical shock.

## General Safety Rules

### ⚠ WARNING



Read all safety warnings and instructions. Failure to follow the warnings and instructions may result in electrical shock, fire, and/or serious injury.

### SAVE THESE INSTRUCTIONS!

## Work Area Safety

- **Keep your work area clean and well lit.** Cluttered or dark areas invite accidents.
- **Do not operate equipment in explosive atmospheres, such as in the presence of flammable liquids, gases, or dust.** Equipment can create sparks which may ignite the dust or fumes.
- **Keep children and bystanders away while operating equipment.** Distractions can cause you to lose control.
- **Avoid traffic.** Pay attention to moving vehicles when using on or near roadways. Wear high-visibility clothing or reflector vests.

## Electrical Safety

- **Avoid body contact with earthed or grounded surfaces such as pipes, radiators, ranges, and refrigerators.** There is an increased risk of electrical shock if your body is earthed or grounded.
- **Do not expose equipment to rain or wet conditions.** Water entering equipment will increase the risk of electrical shock.
- **Keep all electrical connections dry and off the ground.** Touching equipment or plugs with wet hands can increase the risk of electrical shock.
- **Do not abuse the cord.** Never use the cord for carrying, pulling, or unplugging the power tool. Keep cord away from heat, extreme cold, oil, sharp edges, and moving parts. Damaged or entangled cords increase the risk of electrical shock.
- **If operating equipment in a damp location is unavoidable, use a ground fault circuit interrupter (GFCI) protected supply.** Use of a GFCI reduces the risk of electrical shock.

## Personal Safety

- **Stay alert, watch what you are doing, and use common sense when operating equipment.** Do not use equipment while you are tired or under the influence of drugs, alcohol, or medication. A moment of inattention while operating equipment may result in serious injury.
- **Dress properly.** Do not wear loose clothing or jewelry. Loose clothes, jewelry, and long hair can be caught in moving parts.
- **Practice good hygiene.** Use hot, soapy water to wash hands and other body parts exposed to drain contents after handling or using drain inspection equipment. To prevent contamination from toxic or infectious material, do not eat or smoke while operating or handling drain inspection equipment.
- **Always use appropriate personal protective equipment when handling and using equipment in drains.** Drains may contain chemicals, bacteria, and other substances that may be toxic, infectious, and cause burns or other issues. Appropriate personal protective equipment always includes safety glasses and may include a dust mask, hard hat, hearing protection, drain cleaning gloves or mitts, latex or rubber gloves, face shields, goggles, protective clothing, respirators, and steel toed, non-skid footwear.
- **If using drain cleaning equipment and drain inspection equipment at the same time, wear RIDGID drain cleaning gloves.** Never grasp the rotating drain cleaning cable with anything else, including other gloves or a rag which can become wrapped around the cable and cause hand injuries. Only wear latex or rubber gloves underneath RIDGID drain cleaner gloves. Do not use damaged drain cleaning gloves.

## Equipment Use and Care

- **Do not force equipment.** Use the correct equipment for your application. The correct equipment does the job better and more safely.
- **Do not use equipment if the power switch does not turn it on and off.** Any equipment that cannot be controlled with the power switch is dangerous and must be repaired.
- **Disconnect the plug from the power source and/or the battery pack from the equipment before making adjustments, changing accessories, or storing.** Preventive safety measures reduce the risk of injury.
- **Store idle equipment out of the reach of children and do not allow persons unfamiliar with the equipment or these instructions to operate the equipment.** Equipment can be dangerous in the hands of untrained users.
- **Maintain equipment.** Check for misalignment or binding of moving parts, missing parts, breakage of parts, and any other condition that may affect the equipment's operation. If damaged, have the equipment repaired before use. Many accidents are caused by poorly maintained equipment.
- **Do not overreach.** Keep proper footing and balance at all times. This enables better control of the equipment in unexpected situations.
- **Use the equipment and accessories in accordance with these instructions, taking into account the working conditions and the work to be performed.** Use of the equipment for operations different from those intended can result in a hazardous situation.
- **Use only accessories that are recommended by the manufacturer for your equipment.** Accessories that may be suitable for one piece of equipment may become hazardous when used with other equipment.
- **Keep handles dry, clean, and free from oil and grease.** Clean handles give better control of the equipment.
- **Protect the LCD from impacts during use.** Impacts to the front of the LCD can cause glass breakage and complete failure of the display.

## Battery Use and Care

- **Use equipment only with specifically designed battery packs.** Use of any other battery packs may create a risk of injury and/or fire.
- **Recharge only with the charger specified by the manufacturer.** A charger suitable for one type of battery pack may create a risk of fire when used with another battery pack.
- **Do not cover charger while in use.** Proper ventilation is required for correct operation. Covering charger while in use could result in fire.
- **Use and store batteries and chargers in dry, appropriate temperature areas according to their documentation.** Extreme temperatures and moisture can damage batteries and result in leakage, electrical shock, fire, or burns.
- **Do not probe the battery with conductive objects.** Shorting of battery terminals may cause sparks, burns, or electrical shock. When the battery pack is not in use, keep it away from other metal objects, like paper clips, coins, keys, nails, screws or any other small metal object that can make a connection from one terminal to the other. Shorting the battery terminals may cause burns or a fire.
- **Under abusive conditions, liquid may eject from battery; avoid contact.** If contact occurs, flush with water. If liquid contacts eyes, seek medical help. Liquid ejected from the battery may cause irritation or burns.
- **Properly dispose of batteries.** Exposure to high temperatures can cause the batteries to explode; do not dispose of in a fire. Some countries have regulations concerning battery disposal. Follow all applicable regulations.

## Pre-Operation Inspection

### ⚠ WARNING



To reduce the risk of serious injury from electrical shock or other causes, and to prevent damage to your equipment, inspect all equipment and correct any problems before each use.

To inspect all equipment, follow these steps:

1. Power off your equipment.
2. Disconnect and inspect all cords, cables, and connectors for damage or modification.
3. Clean any dirt, oil, or other contamination from your equipment to ease inspection and to prevent it from slipping from your grip during transportation or use.
4. Inspect your equipment for any broken, worn, missing, misaligned, or binding parts, or any other condition which might prevent safe, normal operation.
5. Refer to the instructions for all other equipment to inspect and make sure it is in good, usable condition.
6. Check your work area for the following:
  - Adequate lighting.
  - The presence of flammable liquids, vapors, or dust that may ignite. If present, do not work in area until sources have been identified and corrected. The equipment is not explosion proof. Electrical connections can cause sparks.
  - A clear, level, stable, and dry place for the operator. Do not use the equipment while standing in water.
7. Examine the job to be done and determine the correct equipment for the task.
8. Observe the work area and erect barriers as necessary to keep bystanders away.

See additional product specific safety information and warnings starting on page 10.

## SeeSnake CS6x Versa Overview



### Description

The RIDGID® SeeSnake® CS6x Versa™ Wi-Fi-enabled reporting monitor is an ergonomic, all-in-one solution for capturing media and delivering inspection results to your customers.

The CS6x Versa is compatible with all SeeSnake camera reels and docks onto Compact series reels for convenient viewing, transport, and storage. With an adjustable kickstand and reversible mounting system, the CS6x Versa can be set up to create the optimal viewing angle.

The CS6x Versa captures images and video directly to a USB drive. Professional multimedia reports are automatically created while you work, increasing your productivity and helping you move on to the next job.

Download HQx Live, the free iOS™ or Android™ companion app to use your mobile device as a second screen. Using the CS6x Versa's built-in Wi-Fi, pair a smartphone or tablet to the CS6x Versa to provide uninterrupted, high-quality video streaming directly on the device, letting you show your customers the inspection in real-time. HQx Live also lets you capture media from a paired device.

SeeSnake HQ software streamlines critical and routine updates which help improve and prolong the life of your equipment. HQ also gives you the ability to manage jobs and generate reports for customers. The included 8 GB USB drive comes with HQ preloaded.

For support and additional information about using your CS6x Versa go to [support.seesnake.com/cs6xversa](https://support.seesnake.com/cs6xversa).

Specifications	
<b>Weight without Battery</b>	2.2 kg [4.9 lb]
<b>Dimensions</b>	
Length	332 mm [13.1 in]
Width	233 mm [9.2 in]
Height	309 mm [12.2 in]
<b>Power Source</b>	18 V Li-Ion rechargeable battery or AC adapter
<b>Power Rating</b>	15-25 VDC, 25 W
<b>Display</b>	
Type	Color LCD
Size	145 mm [5.7 in]
Resolution	VGA 640 × 480 pixels
Brightness	460 cd/m <sup>2</sup>
<b>Media</b>	
Standard video	MPEG4 (H.264)
Autolog video	MPEG4 (H.264) Low, variable frame rate for decreased file size
Photo	JPG
PhotoTalk™	MPEG4 (H.264) Single image with audio commentary
Audio	Integrated microphone and speaker

Specifications	
<b>Transfer Method</b>	2.0 USB
<b>USB Port</b>	1 x 1.5 A
<b>Connectivity</b>	
Bluetooth	4.0
Wi-Fi	802.11 a/b/g/n
<b>Operating Environment</b>	
Temperature*	-10°C to 50°C [14°F to 122°F]
Storage temperature	-10°C to 70°C [14°F to 158°F]
Ingress protection	IP×5
Relative humidity	5 to 95 percent
Altitude	4,000 m [13,120 ft]
*The AC adapter is rated for 0°C to 40°C [32°F to 104°F]. Using the AC adapter may limit operation in extreme temperatures.	

### Standard Equipment

- SeeSnake CS6x Versa
- AC Adapter (USA)
- AC Adapter (Europe)
- 8 GB USB Drive (with HQ preloaded)
- Operator's Manual



## Components

Note: The maximum USB drive length for the USB port cover to close is 50 mm [2 in].

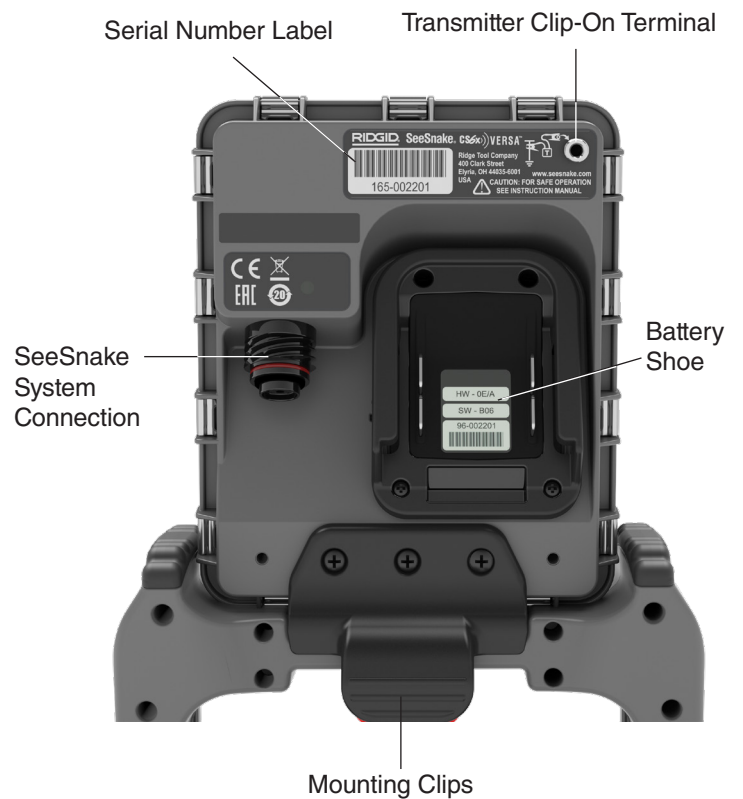
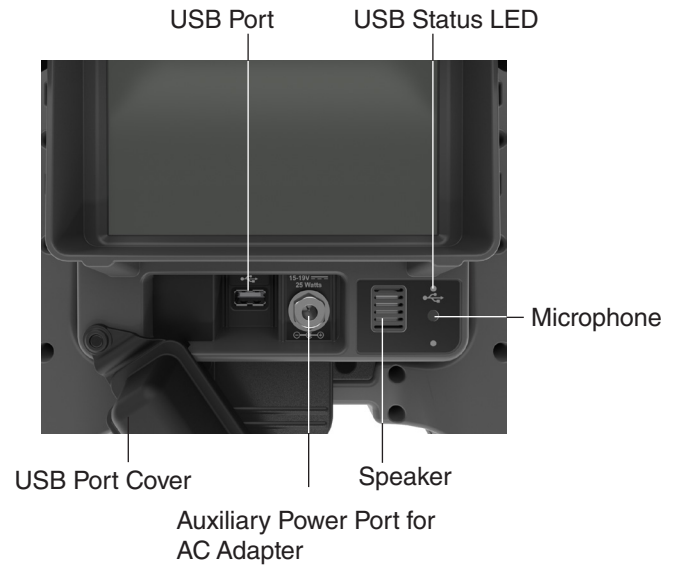

## Operating Instructions

### ⚠ WARNING



This section contains important safety information that is specific to the RIDGID® SeeSnake® CS6x Versa. Read these precautions carefully before using the CS6x Versa to reduce the risk of electrical shock, fire, and/or serious injury.

### SAVE ALL WARNINGS AND INSTRUCTIONS FOR FUTURE REFERENCE!

## SeeSnake CS6x Versa Safety

- **Read and understand this manual, the camera reel manual, and the instructions for any other equipment you are using before operating the equipment.** Failure to follow all instructions may result in property damage and/or serious injury. Keep this manual with the equipment for future use.
- **Do not operate the unit if you or the equipment are standing in water.** Operating the equipment while in water increases the risk of electrical shock. Rubber-soled, non-slip shoes can help prevent slipping and electrical shock on wet surfaces.
- **The battery shoe and other electrical equipment and connections are not waterproof.** Do not expose the equipment to wet locations.
- **Only power the system with a compatible battery or AC adapter.** Use of any other battery may create a risk of fire and/or injury. When powered by a battery, protect the monitor from exposure to weather.
- **The AC adapter is not waterproof and is intended for indoor use only.** To prevent electrical shock do not power the system with an AC adapter outdoors or in wet conditions.
- **The monitor is not designed to provide high voltage protection and isolation.** Do not use where a danger of high voltage contact is present.
- **Do not expose the unit to mechanical shocks.** Exposure to mechanical shocks can damage equipment and increases the risk of serious injury.
- **Carrying the system incorrectly can cause the CS6x Versa to disengage from the docking system and may result in property damage and/or serious injury.** Never carry the Compact series reel by the CS6x Versa's handle when transporting the system. Always use the frame handle on the Compact reel.

## Inspection Overview

### ⚠ WARNING



Wear appropriate protective equipment such as latex or rubber gloves, goggles, face shields, and respirators when inspecting drains that might contain hazardous chemicals or bacteria. Always wear eye protection against dirt and other foreign objects.

The following is an overview of how to perform a pipe inspection with your SeeSnake system:

1. Connect the monitor to a camera reel with the system cable.
2. Press the Power key .
3. Carefully put the camera into the pipe. Protect the push cable from sharp edges at the pipe entrance.
4. Push the camera through the pipe and observe the display.
5. Depending on the requirements for the job, you may want to include one or more of the following:
  - Capture media.
  - Stream live video to your mobile device and share media with customers.
  - Locate an inspection point or path.
  - Take a temporary segment distance measurement.
  - Add custom overlay.
  - Review the job, captured media, and preview the report.
  - Deliver a report to your customer on a USB drive.

## Connecting to a Camera Reel

The CS6x Versa can connect to any SeeSnake camera reel with the SeeSnake system cable.

1. Pull back the outer locking sleeve on the system cable connector.
2. Align the connector ridge and plastic guide pin with the socket and push the connector straight in.
3. Tighten the outer locking sleeve.

**NOTICE** Only twist the outer locking sleeve. To prevent damage to the pins, never bend or twist the connector.

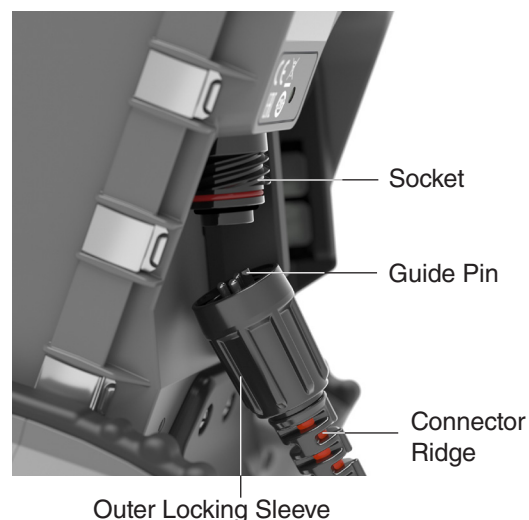

## Powering the System









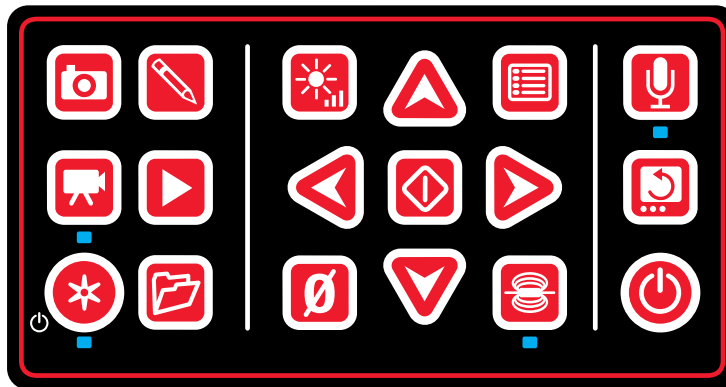

**NOTICE** Unexpected power loss may result in data loss and corruption.





The system is powered by a compatible 18 V Li-Ion rechargeable battery or AC adapter. Battery run time will vary according to battery capacity and use.

*Note: The AC adapter does not recharge the 18 V battery.*

## Keypad









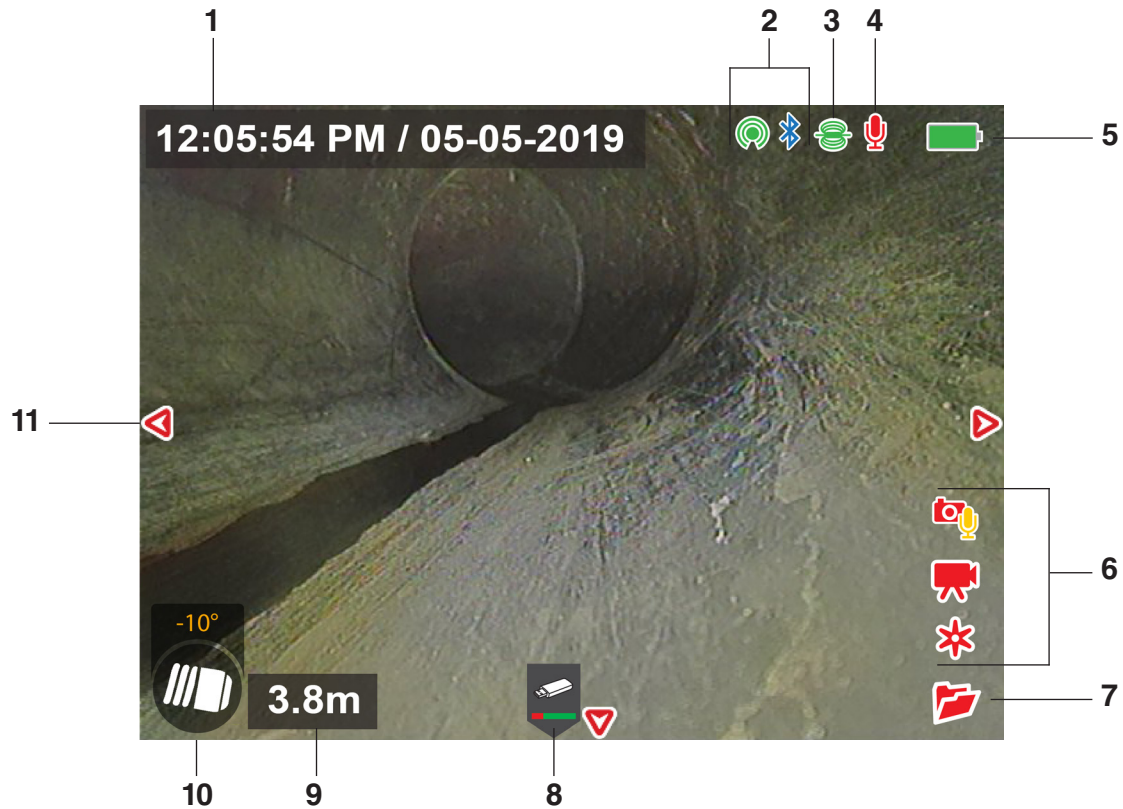





Keys and Functions		
Keypad	Key Name	Function
	Power	Power on and off.
	Arrows	Navigate through menus and screens and increase or decrease volume during playback. Press left, right, or down arrow in live feed for Quick Access Menus.
	Select/Pause	Select highlighted items and apply changes. When recording standard video or Autolog video, press to pause and resume recording.
	Menu	Open the menu to modify settings, including connectivity, reel, camera, region, and more. Press to exit out of tabs and screens.
	Photo/PhotoTalk™	Press to capture a photo or press and hold to create a PhotoTalk. Default key action can be swapped in the settings menu.
	Video	Start and stop standard video recording.
	Autolog	Start and stop Autolog video recording. Optionally press once to power on and start Autolog video recording simultaneously.
	Text	Add and edit custom overlay text.
	Review	Open the Job Review screen to review captured media, playback videos, add notes, enter customer and job location information, and preview the report for the open job.
	Job Manager	Open the Job Manager to view the job list, create a new job, preview an existing job, enter company information, or delete jobs from the USB drive.

Keys and Functions		
Keypad	Key Name	Function
	LED Brightness	Control the brightness of the LEDs in the camera.
	Zero	Long press (>3 seconds) to set the system measurement to zero at the beginning of an inspection. Short press (<1 second) to start and stop temporary segment measurements. The temporary segment measurement appears in brackets.
	Sonde	Enable and disable the sonde.
	Microphone Mute	Enable and disable the microphone.
	Image Flip	Short press (<1 second) to rotate the view 180 degrees. The rotated image appears in captured media. Long press (>3 seconds) to rotate the user interface 180 degrees.

## User Interface



User Interface			
1	Time and Date Overlay	---	Options: Show time only, date only, both, or neither.
2	Connectivity		Wi-Fi not connected.
			Wi-Fi connected.
			Bluetooth enabled but not connected.
			Bluetooth connected.
3	Sonde		Sonde enabled and transmitting.
4	Microphone		Microphone enabled.
			Audio recording in progress.
			Microphone disabled.
5	Power		Battery power level indicator.
			AC Power.

User Interface		
6	Media Capture Icons	 Photo captured.
		 PhotoTalk™ media created.
		 Video recording.
		 Video recording paused.
		 Autolog video recording.
		 Autolog video recording, motion detected.
		 Autolog video recording paused.
7	Open Job	 A job is open.
8	USB Status	 USB drive inserted. <b>Safe to remove the USB drive.</b>
		 <b>Do not remove the USB drive!</b> Media is being written to the USB drive. Premature removal of the USB drive may result in data loss and corruption.
		 Media transfer complete. <b>Safe to remove the USB drive.</b>
9	Count Overlay	--- Options: Show or hide count overlay.
10	TiltSense	 TiltSense™ inclinometer reading. Must be connected to a SeeSnake camera reel with TruSense™ technology.
11	Quick Access Menus	 A Quick Access Menu is open.



## Viewing System

The CS6x Versa's position can be adjusted to create a desired viewing angle. Grasp the mounting frame and rotate the kickstand to adjust the viewing angle.

### Mounting the CS6x Versa

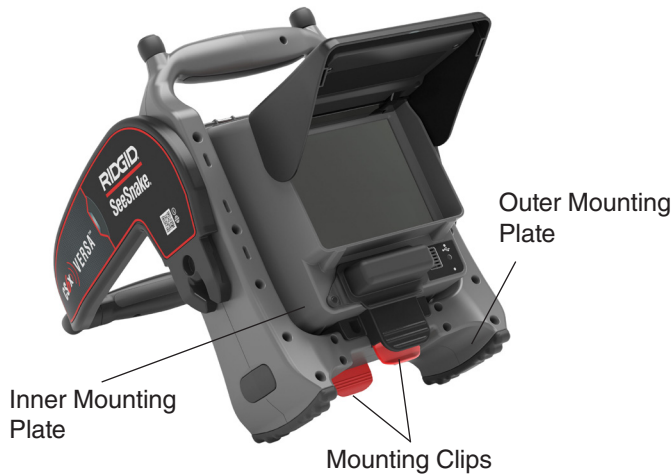

The CS6x Versa can be seated on either the inner or outer mounting plate to bring it into a low or high position.

1. Remove the CS6x Versa from the frame. Squeeze each pair of black and red mounting clips until the monitor disengages from the plate.
2. Center the CS6x Versa over the desired mounting plate.
3. Firmly push the monitor down until you hear the clips lock the monitor into place.

## Docking

The CS6x Versa is designed to dock onto the Compact M40, Compact C40, and Compact2 reels.

Ensure the docking joints on both sides of the CS6x Versa are locked into the joint sockets. Always carry the system by the Compact reel's frame handle.

1. Turn the docking joints on sides of the kickstand so that the openings point down.



Docking Joint

2. Center the CS6x Versa over the docking fins and align the docking joints with the joint sockets.

Joint Sockets

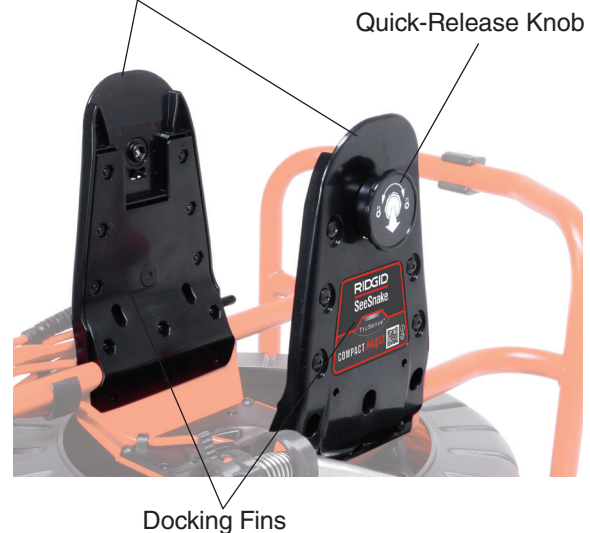

Docking Fins

3. Firmly push the monitor down into the docking system until you feel the monitor lock into place.



## Docking Placement

The monitor can be docked onto the reel while mounted in either the low or high position. Mount the CS6x Versa in the desired position before docking it onto the reel.



*Low position option*



*High position option*

## Removing the Monitor

1. Place the Compact reel so you can grasp both quick-release knobs.
2. Pull both knobs out and away from the docking fins. In the same motion as pulling the knobs out, turn the knobs together in either direction to disengage the locks.

*Note: The locks are disengaged when the yellow indicator labels are visible under the knobs.*

3. Grip the CS6x Versa mounting frame and pull the monitor straight up.

## Maintenance and Support

### Product Support

For support and additional information about using your system, visit [support.seesnake.com/cs6xversa](http://support.seesnake.com/cs6xversa).

### Software Updates

Critical and routine software updates for your SeeSnake monitor are released through HQ. Staying up to date with HQ software prolongs and improves the life and usefulness of your equipment.

### Cleaning

#### **WARNING**



**To reduce the risk of electrical shock, disconnect all cords and cables and remove the battery or other power supply from the CS6x Versa before cleaning.**

The best way to clean the unit is with a damp cloth. Close the USB port cover before cleaning. Do not hose down or allow any liquid or moisture to enter the unit. Do not use liquid or abrasive cleaners. Only clean the display with cleaners approved for use on LCDs.

## Transport and Storage

Store and transport your system with the following in mind:

- Store in a locked area out of the reach of children and people unfamiliar with its purpose.
- Store in a dry place to reduce risk of electrical shock.
- Store away from heat sources such as radiators, heat registers, stoves, and other products (including amplifiers) that produce heat.
- Storage temperature should be -10 °C to 70 °C [14 °F to 158 °F].
- Do not expose to heavy shocks or impacts during transport.
- Remove the battery before shipping and before storing for extended periods of time.

## Service and Repair

**Improper service or repair can cause the CS6x Versa to be unsafe to operate.**

Service and repair of the CS6x Versa must be performed at a RIDGID Independent Authorized Service Center. To maintain the safety of the monitor, make sure a qualified repair person services your unit using only identical replacement parts. Discontinue using the CS6x Versa, remove the battery, and contact service personnel under any of the following conditions:

- If liquid has been spilled or objects have fallen into the equipment.
- If the equipment does not operate normally when operating instructions are followed.
- If the equipment has been dropped or damaged.
- If the equipment exhibits a distinct change in performance.

For information on your nearest RIDGID Independent Service Center or any service or repair questions:

- Contact your local RIDGID distributor.
- Go to [www.RIDGID.com](http://www.RIDGID.com).
- Contact Ridge Tool Company Technical Service Department at [rttechservices@emerson.com](mailto:rttechservices@emerson.com) or, in the U.S. and Canada, call 1-800-519-3456.

## Disposal

Parts of your system contain valuable materials that can be recycled. There are companies that specialize in recycling that may be found locally. Dispose of the components in compliance with all applicable regulations. Contact your local waste management authority for more information.



**EC Countries:** Do not dispose of electrical equipment with household waste!

According to the European Guideline 2012/19/EU for Waste Electrical and Electronic Equipment and its implementation into national legislation, electrical equipment that is no longer usable must be collected separately and disposed of in an environmentally correct manner.

## Battery Disposal

**EC Countries:** Defective or used battery packs/batteries must be recycled according to the guideline 2006/66/EC.

**Ridge Tool Company**  
400 Clark Street  
Elyria, Ohio 44035-6001  
USA

1-800-474-3443

**Ridge Tool Europe NV (RIDGID)**  
Ondernemerslaan 5428  
3800 Sint-Truiden  
Belgium

+32 (0)11 598 620

© 2019 Ridge Tool Company. All rights reserved.

Every effort has been made to ensure that the information in this manual is accurate. Ridge Tool Company and its affiliates reserve the right to change the specifications of the hardware, software, or both as described in this manual without notice. Visit [www.RIDGID.com](http://www.RIDGID.com) for current updates and supplemental information pertaining to this product. Due to product development, the photos and other presentations specified in this manual may differ from the actual product.

RIDGID and the RIDGID logo are trademarks of Ridge Tool Company, registered in the USA and other countries. All other registered and unregistered trademarks and logos mentioned herein are the property of their respective owners. Mention of third-party products is for informational purposes only and constitutes neither an endorsement nor a recommendation.

iPad, iPhone, iPod touch, and App Store are trademarks of Apple Inc., registered in the USA and other countries. "Made for iPod," "Made for iPhone," and "Made for iPad" mean that an electronic accessory has been designed to connect specifically to iPod, iPhone, or iPad respectively, and has been certified by the developer to meet Apple performance standards. Apple is not responsible for the operation of this device or its compliance with safety and regulatory standards. Please note that the use of this accessory with iPod, iPhone, or iPad may affect wireless performance.

IOS is a trademark or registered trademark of Cisco in the USA and other countries and is used under license by Apple Inc.

The Bluetooth word mark and logos are owned by the Bluetooth SIG, Inc.

Android and Google Play are trademarks of Google Inc.